

crest
showers

**S E R E N E X
W A L K I N
I N S T A L L A T I O N
I N S T R U C T I O N S**

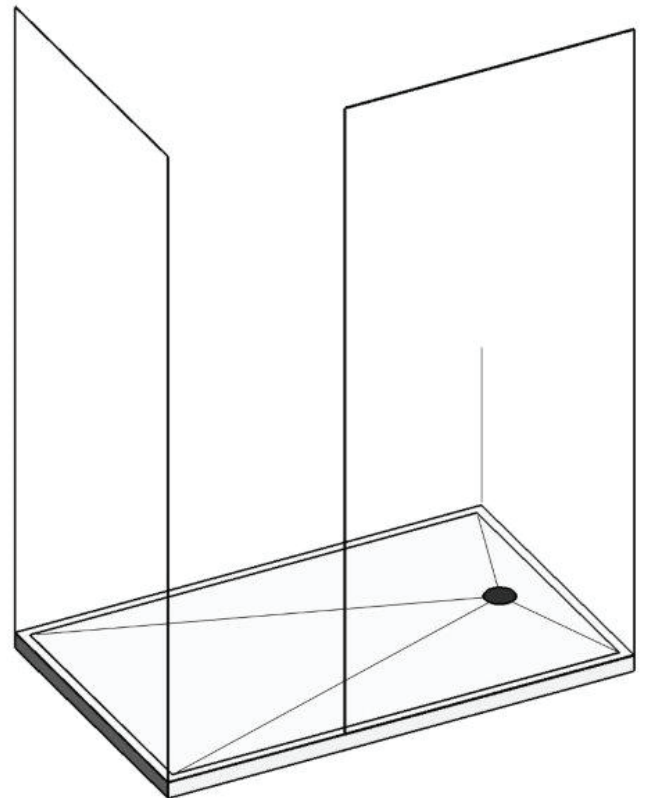

SERENEX WALK IN INSTALLATION INSTRUCTIONS

NOTE: Read and understand all instructions before installing shower.

GENERAL SHOWER INFORMATION

- Due to weight of panels and base, 2 people may be needed to install shower.
- Walls must be plumb to a 2-3mm tolerance where shower is to be installed.
- Floor must be square to wall.

GLASS SAFETY

- Keep glass standing upright.
- Always sit glass on a padded surface i.e. polystyrene.
- Take extra precautions with edges of glass panels.
- If toughened safety glass hits a hard surface or is hit by a hard object, it may shatter or compromise the integrity of the glass.
- It is recommended that safety gloves and glasses are worn during installation.

SERENEX WALK IN / /



PARTS LIST

INCLUDED

1. Glass Panels
2. Channel Extrusion Kits
3. Installation Kit
4. Shower Base
5. Easy Clean Waste
6. Silicone & Adhesive
7. Hardware

NEEDED

1. Caulking Gun
2. Level
3. Masking Tape
4. Drill
5. Screw Driver
6. Spray Bottle with Soapy Water
7. Paper Towels
8. Tape Measure
9. Gib Cutter (if Gib already run to the floor).

SERENEX WALK IN INSTALLATION INSTRUCTIONS

IMPORTANT INFORMATION

Please read all instructions and warranty information before beginning installation.

It is assumed that this instruction is being carried out by qualified trades-people.

The Serenex shower base is a durable product but care must be taken during installation. Rough handling, impacts to wall flanges and other areas can cause unnecessary breaks which are not covered under warranty.

Please carefully **lift** and **lower** the shower base into position. Suction handles as used by glaziers can be very useful for this. **DO NOT DROP, HIT OR SLIDE SHOWER BASE.**

Once out of its freight packaging and after installation we firmly recommend keeping the surface covered to remove the risk of unnecessary damage i.e. dropped tools, tiles, glass, paint etc. The packaging can be easily cut down/modified to make a covering until work is complete.

SERENEX ORDER OF SHOWER INSTALLATION WITH ACRYLIC LINER

1. Base
2. Gib Lining
3. Acrylic Liner
4. Channels
5. Glass

SERENEX ORDER OF SHOWER INSTALLATION WITH TILED WALLS

1. Base
2. Gib Lining
3. Water Proofing
4. Channels
5. Tiles
6. Glass

INSTALLATION INSTRUCTIONS

1. DRY FITTING THE BASE

- Clean/prepare floor surface in accordance with directions on adhesive. Check floor for level surface, noting any humps and falls. The floor must be completely clean and free from all dust. Walls should be plumb.
- Fit the shower base into position by carefully lifting and lowering into place. The shower base must fit square/plumb to adjacent walls and be rock solid under foot.
- Ensure inside face of the upstand is flush with the Gib. Our acrylic shower bases are designed with an upstand that requires the tray to be fitted hard up against the timber framing and for the GIB board to sit flush with the top of the upstand. This allows the acrylic liner or waterproofing to cover that join between the upstand and Gib, creating a waterproof seal.
- If the GIB board has been fitted down to the floor and covering the framing where the base needs to be, you need to place the tray up against that area and using a pencil trace along the top of the upstand onto the Gib.
- Remove the base and cut the Gib along the pencil line with a Gib cutter and remove. This will give you the necessary clearance to fit the base up against the framing.
- Once base is re-positioned, connect the waste trap according to the manufacturer's instructions.

SERENEX WALK IN INSTALLATION INSTRUCTIONS

2. FIX THE SHOWER BASE IN PLACE

- Silicone the join between the bottom of the GIB and the top of the upstand.
- The use of additional structural strength can be obtained by gluing the tray to the floor with an approved adhesive. Please ensure the tray is level and true before the final fixing.

WATERPROOFING FOR ACRYLIC LINERS

You do not need to add the extra waterproof bandage or membrane if installing an acrylic liner as this acts as the waterproofing method (FIG 1). Please see Crest's Acrylic Wall Liner Instructions for application procedure.

WATERPROOFING FOR TILED WALLS

Crest Showers recommends applying a waterproof bandage covering the join between the top of the upstand and the bottom of the Gib board before applying waterproofing membrane down to the bottom of the upstand (FIG 2). However, it is up to your registered waterproofer's discretion whether they wish to follow this recommendation.

ACRYLIC LINERS

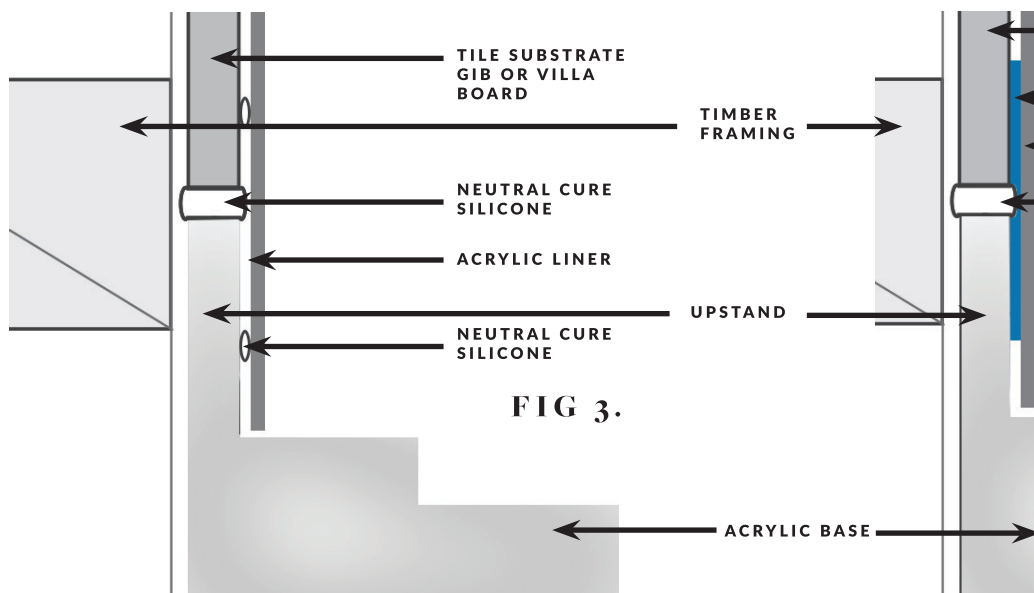

TILED WALLS

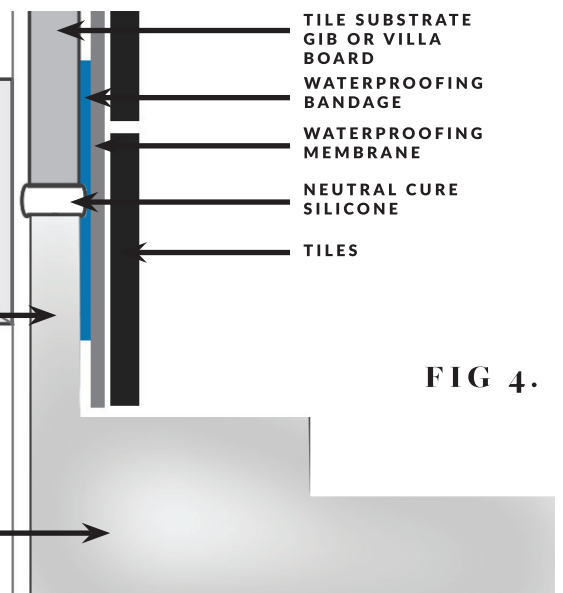

SERENEX WALK IN INSTALLATION INSTRUCTIONS

crest
showers

3. ACRYLIC LINER

If using an acrylic liner, ensure this is done before the wall channels are installed.

4. INSTALLING GLAZING CHANNELS

- Use a 2 meter level to check walls are within 2-3mm of plumb.
- Using measurements on dimension sheet, mark out channel positions on base. Set out floor channels and check shower entry space dimensions are correct.
- Clean base and underside of channel with a dry rag. Run a thick bead of silicone along underside of floor channel (FIG 5).
- Place floor channel in position and press downwards. Remove plastic from stabilizer blocks and stick to base either side of channel to keep in place (FIG 6).
- Slide wall channel on top of floor channel, making sure they butt up to each other and insert channel connector inside 'wall to floor' joint to help line up the wall channel (FIG 7).
- When plumb, drill 2 holes (3.5mmD) in wall channel, lining up with framing locations. (FIG 8). The top hole should be within 100mm of top of channel and the second hole within 1000mm of top of channel. No screws will be required lower than 1000mm up from bottom of base.
- Remove dust from holes and from inside floor channel.
- Clean underside of wall channel with a dry rag before running a thick bead (be very liberal to allow overflow and proper adhesion) of silicone in a continuous line down the entire length of the back of the wall channel (FIG 5) and place on wall. Pop out channel connector and apply silicon into the floor to wall junction, popping the channel connector back in once done.
- Inject silicone into and around screw holes (FIG 8). Ensure wall channel is plumb, then screw in place.

IMPORTANT:

PLEASE MEASURE WALL CHANNELS

For walk in showers, wall channels will measure 1940mm.

If custom panels, your wall channels will measure 10mm less than your glass height.

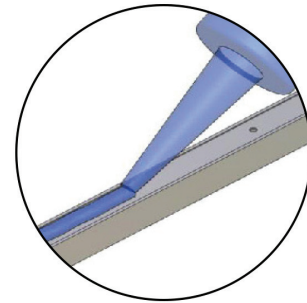

FIG 5.

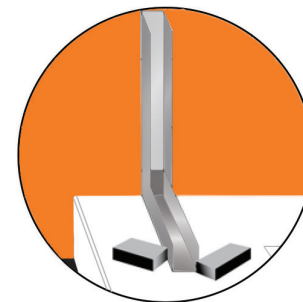

FIG 6.

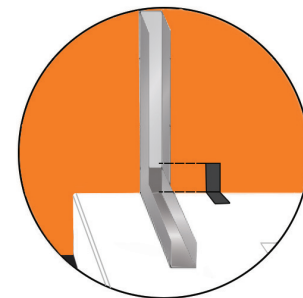

FIG 7.

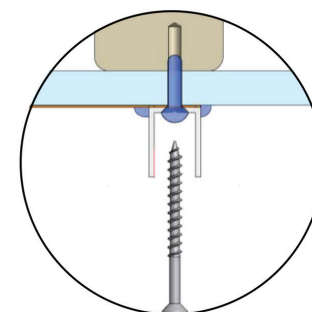

FIG 8.

GLAZING CHANNELS

IMPORTANT

As an added waterproofing precaution, you can apply a continuous bead of silicon down the whole length of wall channel either on the interior or exterior of the wall channel as at your discretion.

SERENEX WALK IN INSTALLATION INSTRUCTIONS

5. TILING

If tiling, ensure this is done after the wall channels are installed, and before the glass panels are fitted.

IMPORTANT: We highly recommend dry fitting fixed panels prior to installation to ensure exact measurements of required walk in gap is achieved as pictured in supplied dimension sheet. Ensure all fixed panels are plumb and level. Use setting blocks as required to achieve this.

6. INSTALLING PANELS

- When panels are correctly aligned, remove panel and run a thick continuous line of silicone down the inside of the wall channel (FIG 10) and apply liberally in the base to channel join and along floor channel up to length of panel.
- Slide glass panel into position (FIG 11) and use small wedges (FIG 12) or a flat plastering blade to slide glass panel back to inside edge of channel and against silicone.

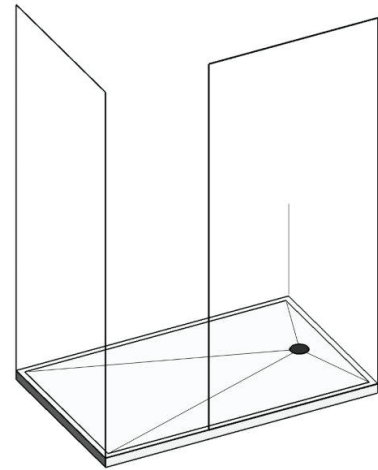

FIG 9.

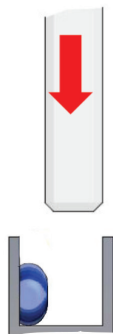

FIG 10.



FIG 11.

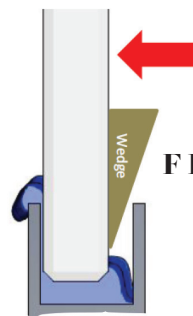

FIG 12.

SERENEX WALK IN INSTALLATION INSTRUCTIONS

7. FINISHING GLAZING CHANEL TO GLASS PANEL JOIN

- Starting at the top of the wall channel, from outside shower, spray with warm soapy water then insert rubber wedge seal into gap (removing timber wedges if used). (FIG 13) Leave rubber wedge protruding 40mm at top to cut off later.

IMPORTANT: Rubber wedge must be pressed into channel lightly from top to bottom before pushing right in. This method ensures rubber wedge does not set stretched and then shrink later.

- Repeat steps 7 and 8 with applicable panels.

FOR GLASS TO GLASS JOINS:

- Run a continuous bead of silicon down entire length of 10mm face of installed wall to glass panel and across the floor channel to the width of the glass to glass panel (FIG 14).
- Gently place glass to glass panel into siliconed floor channel and tilt gently upwards until it joins to glass to wall panel (FIG 15). Ensure there is no side to side movement while placing panel as this will smear silicone.
- Hold glass to glass join in place with masking tape (FIG 16).

- Cut off excess rubber wedge then fill the top of channel with silicone.
- Spray channel and glass with slightly soapy water then use spatula provided to clean off excess silicone (FIG 17). Repeat this process 3 times. Use minimal water then wipe off with paper towels.

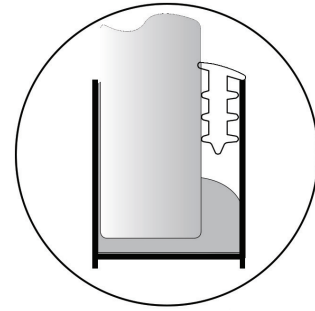

FIG 13.

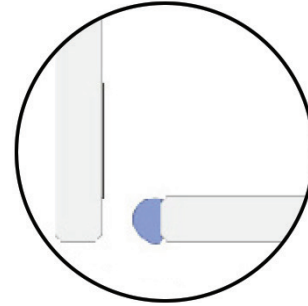

FIG 14.

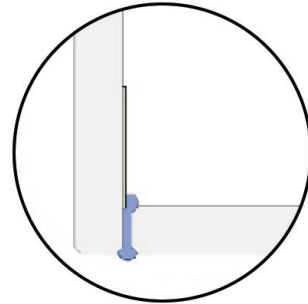

FIG 15.

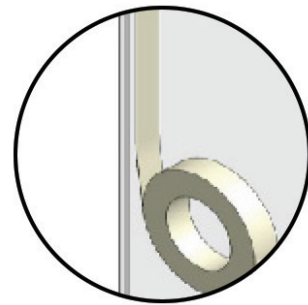

FIG 16.

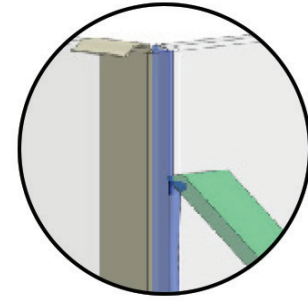

FIG 17.

SERENEX WALK IN INSTALLATION INSTRUCTIONS

9. COMMISSIONING SHOWER

- Clean glass end ensure no silicone residue remains on glass, channel or surrounding area.

10. CARE AND MAINTENANCE

You can keep your Serenex shower looking it's very best by following a few simple guidelines:

- Clean shower twice weekly using a mild detergent in warm water and a soft lint free cloth. Ensure channels, hinges and handle are properly cleaned.
- A quick wipe down with a shower squeegee after each use will prohibit water staining the glass.
- Do not use abrasive cleaners or high strength chemicals on your shower.

11. SERENEX WARRANTY

Crest Shower Systems warrants that when installed as per the supplied instructions, the Serenex Shower System will be free from manufacturing defects for a period of 10 years from the date of sale. This means that apart from the typical surface splash, no water will be allowed to leak into the building structure for a minimum of 10 years.

All products supplied by Crest Shower Systems exceed the requirements of the New Zealand Building Code and all glass is manufactured to meet AS/NZS2208 1996 Grade A Safety Glass and is permanently marked as such in accordance with the code.

Crest Shower Systems will supply replacement parts or product at its discretion, free of charge where product is covered by this warranty and proof of defect has been received within 100 days of first appearance. To ensure warranty remains valid, the supplied care and maintenance instructions must be adhered to and the Crest Warranty form supplied with the product must be complete and returned at time of purchase (hard copy or Online). Warranty is non-transferable.

Crest will be liable for the replacement of products or components including their installation, or for an equivalent product including its installation, should the supplied product or component be declared defective by an authorised Crest Shower Systems representative. Beyond this, Crest will not be liable for any damages including incidental or consequential damages related to the use of this product.

Warranty does not apply to the following situations:

- Shower has been improperly installed.
- Shower has been misused or damaged.
- Shower damaged or defective prior to installation.
- Supplied instructions were not adhered to during installation. Note: Discretion must have been used at all times by installer as each situation may vary.

INSTALLATION WARRANTY

Your approved Crest shower installer should provide you with a written 5 year minimum installation workmanship warranty. Product warranty applies regardless of who has installed the shower.

WARNING

This Serenex Shower has just been installed.

PLEASE DO NOT WORK IN OR AROUND THE SHOWER UNTIL



Any queries feel free to ring me on:



**Best Regards
Your Shower Installer**



CREST SHOWER SYSTEMS

W: www.crestshowers.co.nz

E: sales@crestshowers.co.nz

P: 0800 40 40 42