

NOVASTONE HINGED DOOR INSTALLATION INSTRUCTIONS

crest
showers



NOVASTONE HINGED DOOR INSTALLATION INSTRUCTIONS

IMPORTANT INFORMATION:

Please read all instructions and warranty information before beginning installation. It is assumed that this installation is being carried out by qualified trades-people.

GENERAL SHOWER INFORMATION

- Due to weight of panels and base, 2 people may be needed to install shower.
- Walls must be plumb to a 2-3mm tolerance where shower is to be installed.
- Floor must be square to wall.

GLASS SAFETY

- Keep glass standing upright.
- Always sit glass on a padded surface i.e. polystyrene.
- Take extra precautions with edges of glass panels.
- If toughened safety glass hits a hard surface or is hit by a hard object, it may shatter or compromise the integrity of the glass.
- It is recommended that safety gloves and glasses are worn during installation.



NOVASTONE HINGED DOOR INSTALLATION INSTRUCTIONS

INCLUDED

Glass Panels
Channel Extrusion Kits
Installation Kit
Shower Base
Easy Clean waste
Silicone and Adhesive
Hardware

NEEDED

Caulking Gun
Level
Drill
Screw Driver
Spray Bottle with Soapy Water
Paper Towels
Tape Measure

IMPORTANT INFORMATION:

The Novastone shower base is a durable product but care must be taken during installation. Rough handling, impacts to wall upstands and other areas can cause unnecessary breaks which are not covered under warranty.

Please carefully lift and lower the shower base into position. Suction handles as used by glaziers can be very useful for this. **DO NOT DROP, HIT OR SLIDE SHOWER BASE.** Once out of its freight packaging and after installation we firmly recommend keeping the base surface covered to remove the risk of unnecessary damage i.e. dropped tools, tiles, glass, paint etc. The packaging can be easily cut down/modified to make a covering until work is complete.

SHOWER BASE

1. DRY FITTING THE BASE

- Clean/prepare floor surface in accordance with directions on adhesive. Check floor for level surface, noting any humps and falls. The floor must be completely clean and free from all dust. Walls should be plumb.
- Fit the shower base into position by carefully lifting and lowering into place. The shower base must fit square/plumb to adjacent walls and be rock solid under foot.
- Ensure the inside face of the upstand is flush with the gib (FIG 2). The Novastone shower bases are designed with an upstand that requires the tray to be fitted hard up against the timber framing and for the gib board to sit flush with the top of the upstand. This allows the waterproofing to cover that join between the upstand and gib, creating a waterproof seal.
- If the gib board has been fitted down to the floor and covering the framing where the base needs to be, you need to place the tray up against that area and using a pencil trace along the top of the upstand onto the gib.
- Remove the base and cut the gib along the pencil line with a gib cutter and remove. This will give you the necessary clearance to fit the base up against the framing.
- If required, use plastic packers to level the shower base in all directions, particularly through the drain channel (FIG 1).
- Once sitting level and in correct position, carefully remove tray. Secure packers to the floor to prevent them shifting when refitting tray.
- Once base is re-positioned, connect the waste trap to the shower tray..

FIG.1



FIG.2

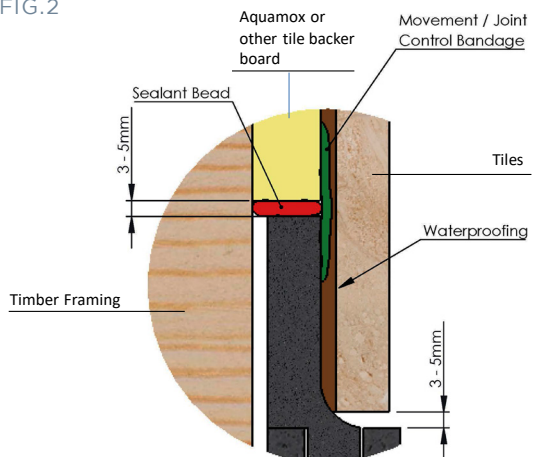

SHOWER BASE

2. FIX THE SHOWER BASE IN PLACE

- Carefully stand shower on edge in vertical position.
- Apply daubs of construction adhesive where each vertical and parallel support meet, making a grid formation (FIG 3).
- Enough adhesive must be applied to contact with the floor and when set will provide a full and even support.
- Re-position shower base in place as per dry fit. Check again for level.
- Seal between top of upstand and bottom of Gib with silicone, ensuring the inside face of both are flush. (FIG 4)
- After 30 minutes you can proceed with care, full curing after 24 hours.

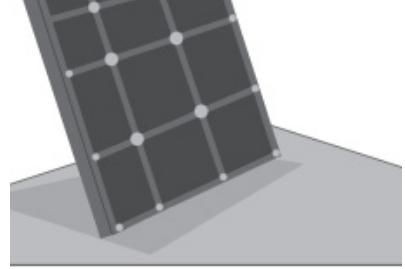

FIG.3

3. WATERPROOFING

Crest Showers recommends applying a waterproof bandage covering the join between the top of the upstand and the bottom of the Gib board before applying waterproofing membrane down to the bottom of the upstand. However, it is up to your registered waterproofer's discretion whether they wish to follow this recommendation.

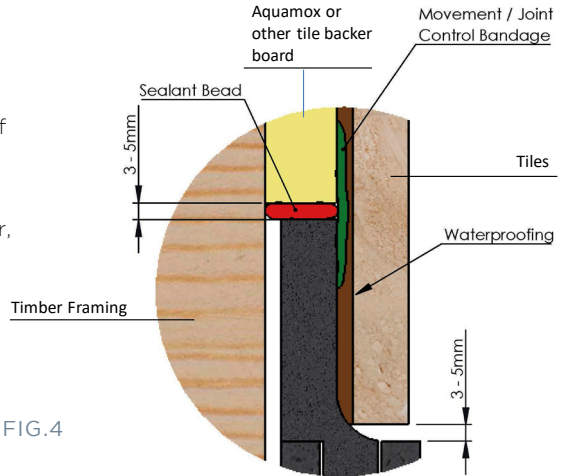

FIG.4

GLAZING CHANNELS

IMPORTANT: PLEASE MEASURE WALL CHANNELS

For hinged door showers, wall channels will measure 1940mm as standard.

For custom panels, your wall channels will measure 10mm less than your glass height.

4. TILING

If tiling the shower enclosure, ensure this is done after the wall channels are installed, and prior to fitting the glass panels.

5. INSTALLING GLAZING CHANNELS

- Use a 2 meter level to check walls are within 2-3mm of plumb.
- Align inside of wall channel with inside of glass recess on the interior side of the base. (FIG 5).
- When plumb, drill 2 holes (3.5mm) in wall channel, lining up with framing locations. (FIG 6). The top hole should be within 100mm of top of channel and the second hole within 1000mm of top of channel. No screws will be required lower than 1200mm up from bottom of base.
- Remove dust from holes and from inside glass recess.
- Clean underside of wall channel with a dry rag before running a thick bead (be very liberal to allow overflow and proper adhesion) of silicone in a continuous line down the entire length of the back of the wall channel (FIG 7) and in the junction between the bottom of the wall channel and glass recess (FIG 8).
- Inject silicone into and around screw holes (FIG 9). Ensure wall channel is plumb, then screw in place.

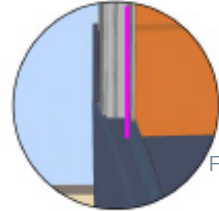

FIG.5

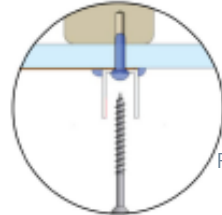

FIG.6

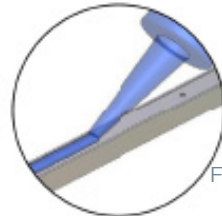

FIG.7

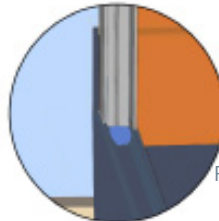

FIG.8

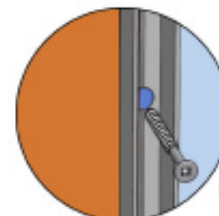

FIG.9

IMPORTANT:

As an added waterproofing precaution, you can apply a continuous bead of silicone down the whole length of wall channel either on the interior or exterior of the wall channel as at your discretion.

GLASS PANELS

IMPORTANT: We highly recommend dry fitting fixed panels prior to installation to ensure exact measurements of required sliding door gap is achieved as pictured in supplied dimension sheet. Ensure all fixed panels are plumb and level. Use setting blocks as detailed below to achieve this.

6. INSTALLING PANELS

- Place a spirit level on top of the floor channel, and insert packers under it to achieve a suitable level.
- Insert an 1mm packer in the wall/floor corner of the channel and add/remove packers, as determined above, at the other end of the panel.
- Repeat for remaining panels
- Ensure that the tops of the panels are all level and in line with each other. You may need to fine tune the packers to achieve this.
- When panels are correctly aligned, remove Panel 1 (FIG 10), and run a thick continuous line of silicone down the inside of the wall channel (FIG 11) and apply liberally in the wall to floor channel join and along the floor channel to the length of the glass panel.
- Now you need your caulk-ing gun with desired silicone color, black N60 for black channels , clear N60 for everything else, you want the nozzle tip as small as possible, starting at the top of the wall channel on the inside of the shower, you now need to pump the silicone into the channel, you need to press hard. The process will fill up the void, eliminate bubbles and complete the seal. Work your way down the wall channel and along the floor channel. Slide glass panel into position (FIG 12) to the inside edge of channel and against silicone. Repeat the process on the other side. Fill up outside edge of channel with more silicone, untill completely full, then spray with soapy water and tool off excess silicone 100%. Inspect and ensure you have a nice tidy finish.
- Ensure panel is still level and plumb.

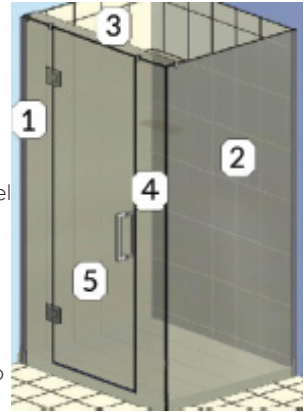

FIG.10

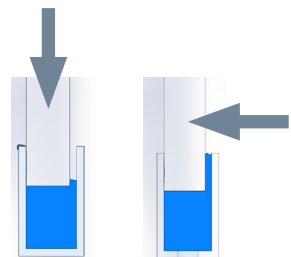
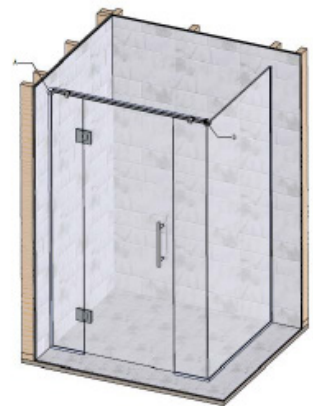

FIG.11

FIG.12

GLASS PANELS

IMPORTANT: For Alcove showers skip step 7 and 8 go to step 9

7. FINISHING GLAZING CHANNEL TO GLASS PANEL JOIN

- Fasten chrome brackets to overhead brace and sit in place above door gap.

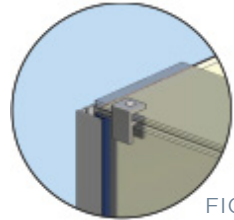

FIG.14

FOR GLASS TO GLASS JOINS

- Dry fit the panel, using the same packer as the panel you are joining to.
- Check that door gap is the same at top and bottom of panels
585mm - 580 mm Door
685mm - 680mm Door
- Run a continuous bead of silicon down entire length of 10mm face of installed wall to glass panel and across floor channel to the width of the glass to glass panel (FIG 15).
- Gently place glass to glass panel into siliconed floor channel and tilt gently upwards until it joins to glass to wall panel (FIG 16). Ensure there is no side to side movement while placing panel as this will smear silicone.
- Hold glass to glass join in place with insulation/masking tape (FIG 16).
- Install Brace Now (Point 8). If Siliconing glass brace on allow silicone to cure for 48hours before installing top rail.
- Spray channels and glass with slightly soapy water then use spatula provided to clean off excess silicone (FIG 18). Repeat this process 3 times. Use minimal water then wipe off with paper towels. Tough Wipes or Baby Wipes are also good to use for this.



FIG.15

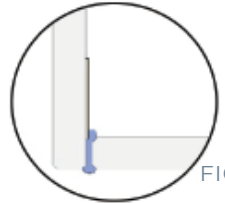

FIG.16

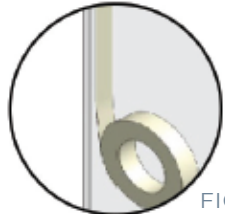

FIG.17

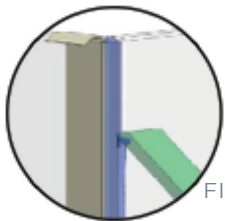

FIG.18

GLASS PANELS

8. INSTALLING THE BRACE

- Once the fixed panels and brace are installed slide the brace into the brackets. Realign the brackets on their panels if necessary and tighten grub screws (FIG19a).

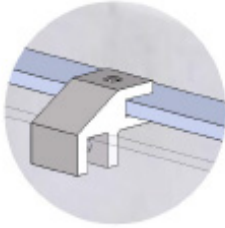

FIG.19A



DOOR PANEL

9. INSTALLING THE DOOR

NOTE: Each hinge plate requires rubber gaskets to protect the glass.

- Fasten hinges to return panel and place in closed position. The screws should face into shower and the hinge pivot point should be on door panel (FIG 20). There must be 1x rubber gasket (supplied) between each hinge plate and the glass to prevent direct contact.
- Place large timber wedges in door way on a cloth to allow you to align the door with the hinges. Standing inside of shower, lift door panel onto the wedges (you may need to adjust the position to attain the correct height and fasten to hinges fully tighten all hex screws but do not over tighten.
- Insert door capping into base recess.

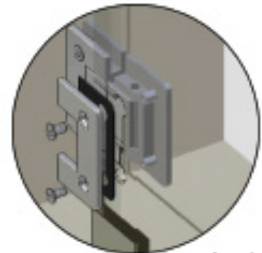

FIG.20

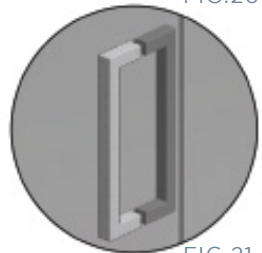

FIG.21

SHELVES

10. INSTALLING SHELVES

Crest Showers Floating Glass Shower Shelf can be installed in any corner of a glass or tile wall. If two shelves are installed in the same corner, ideal shelf heights off the floor are 1200 & 1600mm. When installed in different corners, an ideal height is 1400mm off the floor.

When installing onto Seratone, Hardiglaze or Similar, apply insulation/gaf-fa tape to the liner then adhere the stabiliser block on top of the tape. This makes the blocks easier to remove and protects the wall board surface.

We DO NOT recommend installing these on FLAT acrylic liners, due to adhesion difficulties. They are however, compatible with CREST moulded liners. If you do wish to use on an acrylic surface, ensure the acrylic liner where you are mounting the shelf is roughened with sandpaper and extra time is taken before shelf is used.

IMPORTANT: Protect the shower floor until adhesive has fully cured in case of the unlikely event that shelf/shower is disturbed and the shelf falls.

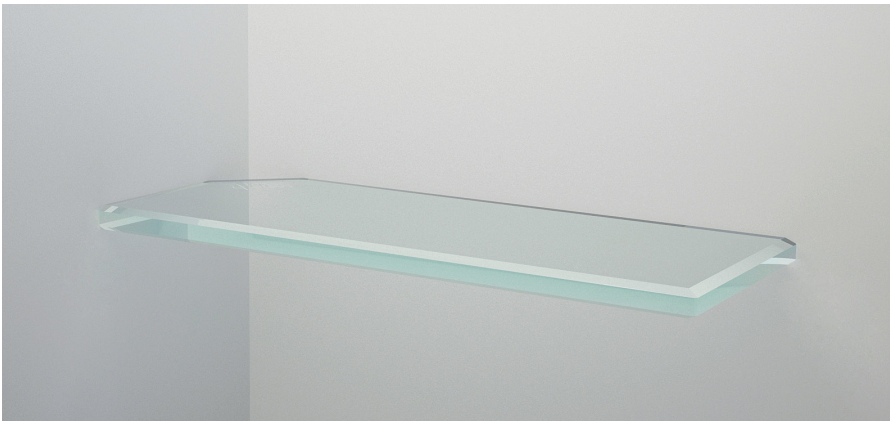

COMMISSIONING YOUR SHOWER

11. COMMISSIONING YOUR SHOWER

- Remove door wedges from underneath door.
NOTE: Door may drop at top up to 1mm as door wedges are removed.
- Open and close door a few times and check that the hinges are quiet. If not, open door half way, loosen hex screws slightly then re-tighten hinges.
- Check that top of door closes in line with return panel. If not, use packers and adjust hinges.
- Check that door springs closed to line up with return panel. If not, adjust hinges. Top and bottom hinges must be treated the same.
- Check that top of door is level with return panel. If not, loosen hex screws slightly, adjust height and re tighten.
- If required, slide drip seal onto bottom of door and trim fin (FIG 35). Seal should just miss top of base when door is shut. If gap between door and floor is too large, seal can be lowered up to 6mm.
- Clean glass and ensure no silicone residue remains on glass, channel or surrounding area.

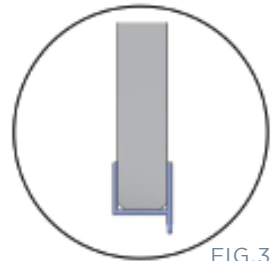

FIG.35

12. INSTALLATION WARRANTY

Your approved Crest shower installer should provide you with a written 5 year minimum installation workmanship warranty. Product warranty applies regardless of who has installed the shower.

CARE AND MAINTENANCE

12. CARE AND MAINTENANCE

You can keep your Novastone shower looking it's very best by following a few simple guidelines:

- Clean shower twice weekly using a mild detergent in warm water and a soft lint free cloth. Ensure channels, hinges and handle are properly cleaned.
- A quick wipe down with a shower squeegee after each use will prohibit water staining the glass.
- Do not use abrasive cleaners or high strength chemicals on your shower.

ROUTINE CARE

Use soapy water (mild dish soap) ammonia based cleaner, (not window cleaner) rinse and wipe completely dry.

DISINFECTING

Diluted bleach (1:1000) for disinfecting can be used, as long as it is rinsed off after a few minutes

RESTORE

Over time, even with proper care, the surface may acquire a patina, changing the appearance of the finish. The following steps can be taken to restore the look of your base.

- First, use soapy water, ammonia based cleaner, (not window cleaner) rinse and wipe completely dry.
- Second, start with a cleaner for removing water marks such as CLR.
- For hard marks and fine scratches use a mild abrasive cleaner such as Jif on a damp cloth and clean surface in circular motions.
- Rinse well and dry.
- Repeat process if necessary until film has been removed.

NOVASTONE WARRANTY

Crest Shower Systems warrants that when installed as per the supplied instructions, the Novastone Shower System will be free from manufacturing defects for a period of 25 years from the date of sale. This means that apart from the typical surface splash, no water will be allowed to leak into the building structure for a minimum of 25 years.

25 YEAR WARRANTY	10 YEAR WARRANTY
Novastone waterproof shower base	Glass screens, hardware and aluminium channels

All products supplied by Crest Shower Systems exceed the requirements of the New Zealand Building Code and all glass is manufactured to meet AS/NZS2208 1996 Grade A Safety Glass and is permanently marked as such in accordance with the code.

Crest Shower Systems will supply replacement parts or product at it's discretion, free of charge where product is covered by this warranty and proof of defect has been received within 100 days of first appearance. To ensure warranty remains valid, the supplied care and maintenance instructions must be adhered to and the Crest Warranty form supplied with the product must be complete and returned at time of purchase (hard copy or Online). Warranty is non-transferable.

Crest will be liable for the replacement of products or components including their installation, or for an equivalent product including its installation, should the supplied product or component be declared defective by an authorised Crest Shower Systems representative. Beyond this, Crest will not be liable for any damages including incidental or consequential damages related to the use of this product.

Warranty does not apply to the following situations:

- Shower has been improperly installed.
- Shower has been misused or damaged.
- Shower damaged or defective prior to installation.
- Supplied instructions were not adhered to during installation.
Note: Discretion must have been used at all times by installer as each situation may vary.
- Shattering panels due to the toughening process, cause cannot be determined.

WARNING

**THIS SHOWER HAS
JUST BEEN INSTALLED**

**PLEASE DO NOT WORK
IN OR AROUND THE
SHOWER UNTIL**

**Any queries, feel free to
ring me on**

**Best regards,
Your Shower Installer**

crest
showers

Head office and showroom

5 Stonehill Drive,
Wiri,
Auckland